



ALLOGRAFT CATALOG



JRF ORTHO

Why JRF Ortho?

- ▶ Exceptional product quality and safety
- ▶ Innovative solutions
- ▶ Superior customer care

JRF Ortho
*is redefining
the standard
for allograft
joint repair.*

TO ORDER

877-255-6727

JRFORTHO.org/order

ABOUT JRF ORTHO

JRF Ortho has a storied history for over a decade **creating progressive solutions** and being recognized for unequalled standard of customer care. Our goal is to partner with surgeons and healthcare professionals to help develop novel techniques for allograft joint repair. As the **largest provider of exceptional joint restoration allografts**, JRF Ortho is the quality standard that you can depend on.

OUR MISSION

Our mission is to improve quality of life through innovative solutions for allograft joint repair.



96% OF CUSTOMERS FEEL JRF ORTHO IS AN ENJOYABLE PARTNER AND EASY TO WORK WITH.

96%

BEYOND MOVEMENT

JRF Ortho supplies the most viable and widely available osteochondral allografts. JRF Ortho also offers Cores, meniscus, and aseptic, sterile and presutured tendons. These grafts are processed by AlloSource® and Solvita™. Local support and instrumentation are provided by Arthrex®.

SUPERIOR CUSTOMER CARE

Your JRF Ortho Allograft Solutions Coordinator (ASC) is highly trained to size match, assess and verify the sizing suitability of the allografts provided for each individual patient. They also coordinate with technicians, physicians and customer service personnel to ensure the proper allograft is delivered for each surgical case.

Our ASC's are available 24/7 to provide superior customer care to handle all technical support needs and emergencies.

PROCESSING WITH PRECISION ENSURING SAFETY & QUALITY

Our partners maintain the highest standards in the recovery, processing, and storage of human tissue providing you confidence in our solutions, products' safety, and efficacy.

- ▶ Recovery of only U.S. donors by recovery agencies' highly trained and qualified tissue specialist teams.
- ▶ Rigorous donor screening and testing in accordance with FDA regulations and standards published by the AATB, including review of donor medical records and social history.
- ▶ Aseptic processing and packaging*
- ▶ Microbial testing is performed on final allografts by a CLIA-certified lab to assure the safety of the allograft for transplantation in accordance with FDA, CLIA and AATB regulations.
- ▶ Use of patented technology and processes designed to penetrate deep within donor tissue to remove blood and lipids and reduce bioburden, with the consistency to ensure the quality allograft you expect every time.
- ▶ Comprehensive post-processing review, including visual inspection of final allografts.
- ▶ Terminal sterility when appropriate.

QUALITY ASSURANCE

The quality assurance programs of our partners ensure compliance with federal and state regulations and voluntary standards.

- ▶ Accredited by the American Association of Tissue Banks
- ▶ Registered with the Food and Drug Administration
- ▶ Member of Donate Life America
- ▶ Member of the Alliance for Regenerative Medicine licensed in California, Florida, Maryland and New York
- ▶ Registered with the Delaware, Illinois and Oregon Procurement Organizations/ Tissue Bank Registries Certified to ISO 13485

All licenses and certifications can be found on our website JRFORTHO.org/info/certification

* Allografts labeled Sterile R are aseptically processed and packaged and then subjected to ultra low gamma or electron beam irradiation. Sterility of our partners' irradiated allografts has been validated in accordance with a technical standard published jointly by the American National Standards Institute (ANSI), the Association for the Advancement of Medical Instrumentation (AAMI), and the International Organization for Standardization (ISO). The FDA Standards Program recognizes the standard, AMI/ANSI/ISO 11137, as a Consensus Standard. The Sterility Assurance Level (SAL) of tissue labeled Sterile is 10⁻⁶.

CONTENTS

TO ORDER

877-255-6727

JRFORTHO.org/order



JRFORTHO

7245 S Havana St, Ste #300
Centennial, CO 80112

M 877-255-6727 F 303-649-1658

JRFORTHO.org

Why JRF Ortho

The JRF Ortho Advantage1
Overview: Osteochondral Allografts, Presutured Sterile Tendons, Nonsutured Sterile Tendons, Nonsutured Aseptic Tendons, Meniscus.....1

Osteochondral Allografts

Precut Fresh OCA Cores, Femoral Condyles, Distal Tibia / Talus.....2
Specialty Allografts.....3

Presutured Sterile Tendons

GraftLink® XL Tendon, PilotGraft BTB Tendon, SpeedGraft® Tendon, SpeedGraft® Achilles Tendon, VersaGraft® Tendon, VersaGraft® 3.5 Tendon.....4

Nonsutured Sterile Tendons

Nonsutured Sterile Allografts 6, 7

Nonsutured Aseptic Tendons

Nonsutured Aseptic Tendon Allografts 8, 9

Meniscus

Meniscus Allografts10

Customer Service

Online Ordering, Shipping, Return Policy12

96%

96% OF CUSTOMERS FEEL JRF ORTHO EXCELS IN TIMELY FULFILLMENT OF CUSTOM OR SPECIALTY ORDERS.

WHY JRF ORTHO

Delivering the most widely available viable cartilage solutions with over 20 years of superior clinical outcomes, JRF Ortho offers surgeons world-class allografts to improve their patients' standard of life.

We have an ample supply of allografts, which are delivered in a timely manner. Our expertise and customer care are unmatched to help you find optimal allografts and efficiencies for surgical procedures. In fact, 96% of customers feel JRF Ortho excels in timely fulfillment of custom or specialty orders.

Through our unique product offering, innovative solutions, and our proven expertise as a tissue supplier, we will continue to preserve and restore your patients' quality of life.

JRF ORTHO ADVANTAGE

- ▶ Shorter wait times and predictable scheduling
- ▶ Higher viability¹
- ▶ Efficiency in the OR
- ▶ Offers both ultra low dose sterilized tendons and aseptic tendons
- ▶ Optimal solutions for small, focal OCA defects

OSTEOCHONDRAL ALLOGRAFTS

Containing mature hyaline cartilage with viable chondrocytes and subchondral bone in an intact unit, OCAs are often used to treat focal cartilage defects offering long-term repair for a patient's damaged hyaline cartilage and underlying bone.

Readily available Precut Fresh OCA Cores are the optimal solution for small, focal osteochondral defects. The Cores contain a mature, viable hyaline cartilage matrix with bone for a superior biomechanical and durable repair of defects without donor site morbidity.

PRESUTURED STERILE TENDONS

Presutured tendons are sterile and preassembled with Arthrex FiberWire® Suture or FiberLoop® Suture for speed and convenience. Each tendon is assembled according to Arthrex specifications, by trained technicians, ensuring that the presutured tendon meets the requirements of the procedure to allow for anatomic, minimally invasive, and reproducible ligament reconstruction.

NONSUTURED STERILE TENDONS

An excellent option for ligament reconstruction procedures, providing advantages such as:

- ▶ Requires less surgical time
- ▶ Allows the patient to avoid donor site morbidity
- ▶ Smaller incisions
- ▶ Availability of larger grafts
- ▶ Early post-operative discomfort and pain is minimized

NONSUTURED ASEPTIC TENDONS

For the surgeon who wants non-irradiated tendon allografts, these tendons are aseptically handled throughout the process, never exposed to irradiation. The unique part code makes certain of what product you are getting.

MENISCUS

Meniscal transplantation is a surgical technique designed to restore the biomechanics of a meniscus deficient knee. Meniscal allograft transplantation provides improvement in regard to pain and level of function for daily activities.



Osteochondral Allografts

Precut Fresh OCA Cores

ALLOGRAFT	VOLUME	PART CODE
Precut Fresh OCA Cores	10 mm	45647010
Precut Fresh OCA Cores	12 mm	45647012
Precut Fresh OCA Cores	16 mm	45647016

Femoral Condyles

ALLOGRAFT	SIDE	PART CODE
Lateral Femoral Condyle	Right	32147001
Lateral Femoral Condyle	Left	32147002
Medial Femoral Condyle	Right	32247001
Medial Femoral Condyle	Left	32247002

Distal Tibia / Talus

ALLOGRAFT	SIDE	PART CODE
Distal Tibia	Right	32747001
Distal Tibia	Left	32747002
Talus	Right	32647001
Talus	Left	32647002



PRECUT FRESH OCA CORES



FEMORAL CONDYLE



TALUS



SCAN OR CLICK

TO ORDER
877-255-6727
JRFORTHO.org/order

Specialty

ALLOGRAFT	SIDE	PART CODE
BiCompartment, Lateral & Trochlea	Right	43747003
BiCompartment, Lateral & Trochlea	Left	43747004
BiCompartment, Medial & Trochlea	Right	43647003
BiCompartment, Medial & Trochlea	Left	43647004
Femoral Trochlea	Right	43547001
Femoral Trochlea	Left	43547002
Whole Distal Femur	Right	33547001
Whole Distal Femur	Left	33547002
Whole Tibial Plateau w/ Meniscus	Right	32447001
Whole Tibial Plateau w/ Meniscus	Left	32447002
Lateral Tibial Plateau w/ Meniscus	Right	45047001
Lateral Tibial Plateau w/ Meniscus	Left	45047002
Medial Tibial Plateau w/ Meniscus	Right	44947001
Medial Tibial Plateau w/ Meniscus	Left	44947002
Patella Bone	Right	33647001
Patella Bone	Left	33647002
Humeral Head	Right	41247001
Humeral Head	Left	41247002
Distal Humerus	Right	44647001
Distal Humerus	Left	44647002
Ulna Proximal	Right	45847001
Ulna Proximal	Left	45847002
Metatarsal Bone, Proximal	Right	44747001
Metatarsal Bone, Proximal	Left	44747002
Metatarsal Bone, Distal	Right	44847001
Metatarsal Bone, Distal	Left	44847002
Femoral Head	Right	41847001
Femoral Head	Left	41847002

For custom grafts, please place your request online or call JRF Ortho directly



HEMI-TIBIAL PLATEAU WITH MENISCUS



PATELLA BONE



HUMERAL HEAD - RIGHT



SCAN OR CLICK

TO ORDER
877-255-6727
JRFORTHO.org/order



Presutured Sterile Tendons

Presutured Sterile Tendons

ALLOGRAFT	LENGTH	DIAMETER	PART CODE
GraftLink® XL Tendon	77-95 mm	8.0-12.5 mm (in 0.5 mm increments)	GRX-001
PilotGraft BTB Tendon	25mm-45mm	10mm (Preshaped bone)	PSP-101
SpeedGraft® Tendon	175-295 mm	8.0-11.0 mm (in 0.5 mm increments)	SPD-001
SpeedGraft® Achilles Tendon	78-113 mm	10mm (Preshaped bone)	PSA-101
VersaGraft® Tendon	150-250 mm	4-5 mm	VRG-001
VersaGraft® 3.5 Tendon	190-240 mm	3.5-4.5 mm	VRG-351

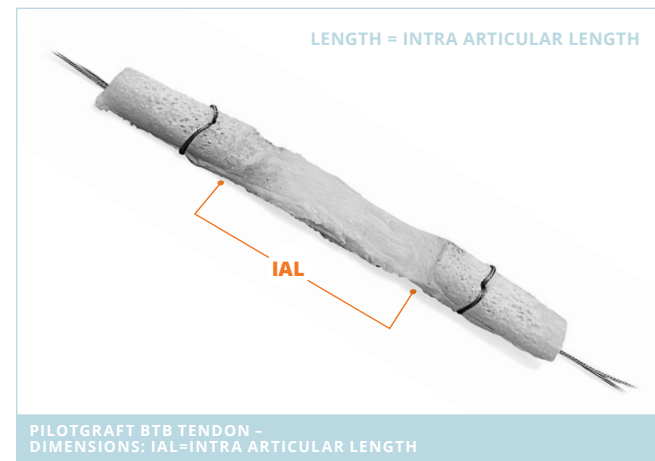
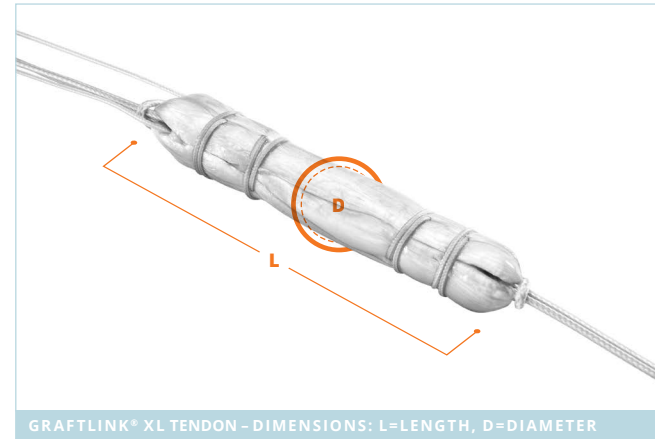

Presutured Sterile Tendons

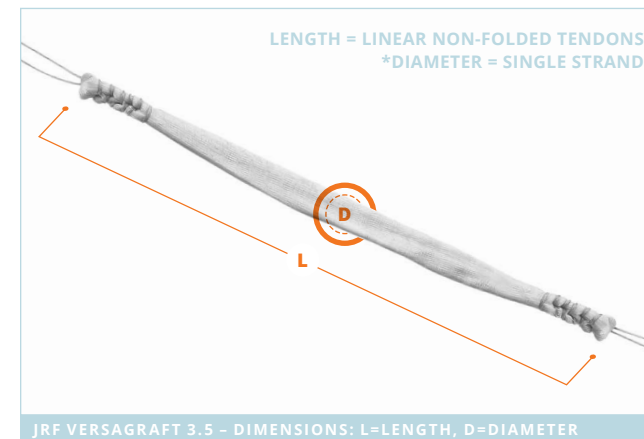
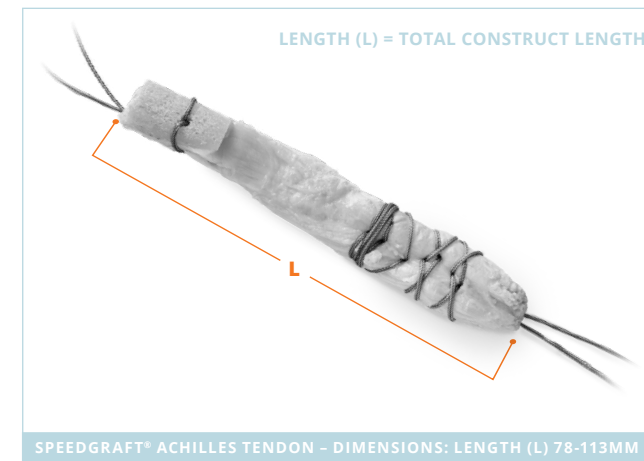
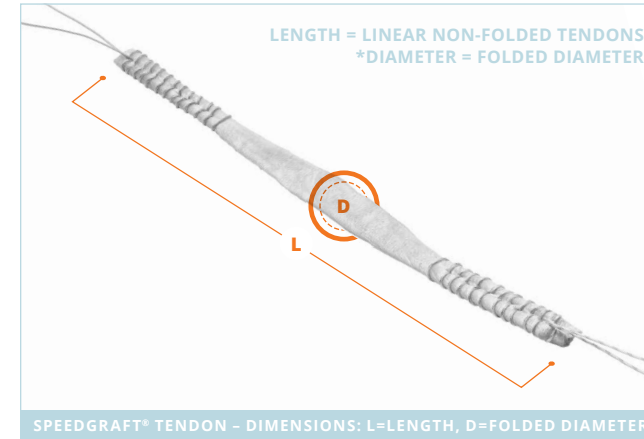

SCAN OR CLICK



TO ORDER
877-255-6727
JRFORTHO.org/order



SCAN OR CLICK



TO ORDER
877-255-6727
JRFORTHO.org/order



Nonsutured Sterile Tendons

Nonsutured Sterile Tendons

Double Strand Tendons: Diameter 7-11 mm, Length >23 cm
Single Strand Tendons: Diameter 3.5-6 mm, Length <23 cm

ALLOGRAFT	PART CODE
Achilles Tendon w/ Bone Block	ACT-001
Achilles Tendon w/o Bone Block	AWO-001
Achilles Tendon, Preshaped, 9 mm	ATP-091
Achilles Tendon, Preshaped, 10 mm	ATP-101
Achilles Tendon, Preshaped, 11 mm	ATP-111
Hemi-Patellar Ligament	HPL-001
Whole Patellar Ligament	WPL-001
Patellar Ligament, Preshaped, 10 mm	PLP-101
Patellar Ligament, Preshaped, 11 mm	PLP-111
Quadriceps Tendon w/ Bone	QDT-001
Quadriceps Tendon, Preshaped, 10 mm	QDT-101
Double Strand Semitendinosus Tendon	DST-001
Double Strand Peroneous Longus	DSP-001
Double Strand Anterior Tibialis	DAT-001
Double Strand Posterior Tibialis	DPT-001
Double Strand Gracilis Tendon	DSG-001



PRE-SHAPED PATELLAR LIGAMENT



NON BONE TENDON



SCAN OR CLICK

TO ORDER
877-255-6727
JRFORTHO.org/order



Nonsutured Sterile Tendons

Nonsutured Sterile Tendons continued...

ALLOGRAFT	PART CODE
Single Strand Semitendinosus Tendon	SST-001
Single Strand Gracilis	SSG-001
Single Strand Anterior Tibialis Tendon	SAT-001
Quadruple Strand Semitendinosus/Gracilis	QSG-001

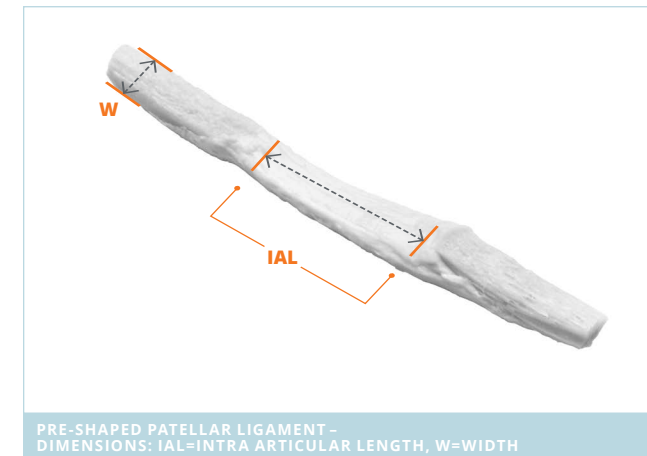

PRE-SHAPED PATELLAR LIGAMENT - DIMENSIONS: IAL=INTRA ARTICULAR LENGTH, W=WIDTH

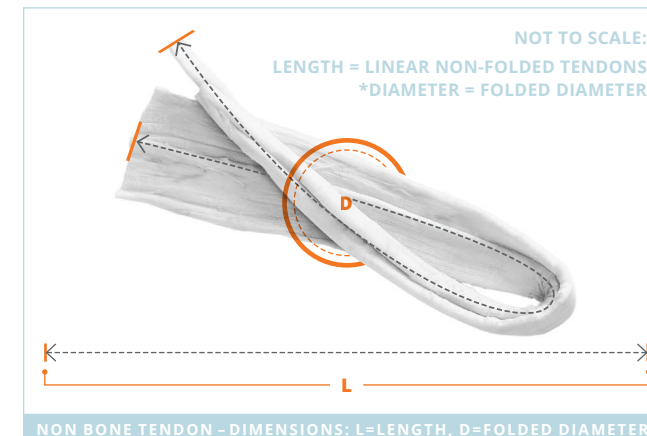

NON BONE TENDON - DIMENSIONS: L=LENGTH, D=FOLDED DIAMETER



SCAN OR CLICK

TO ORDER
877-255-6727
JRFORTHO.org/order





Nonsutured Aseptic Tendons

Nonsutured Aseptic Tendons

Double Strand Tendons: Diameter 7-11 mm, Length >23 cm
Single Strand Tendons: Diameter 3.5-6 mm, Length <23 cm

ALLOGRAFT	PART CODE
Achilles Tendon w/ Bone Block	ACT-002
Achilles Tendon w/o Bone Block	AWO-002
Achilles Tendon, Preshaped, 9 mm	ATP-092
Achilles Tendon, Preshaped, 10 mm	ATP-102
Achilles Tendon, Preshaped, 11 mm	ATP-112
Hemi-Patellar Ligament	HPL-002
Whole Patellar Ligament	WPL-002
Patellar Ligament, Preshaped, 10 mm	PLP-102
Patellar Ligament, Preshaped, 11 mm	PLP-112
Double Strand Semitendinosus Tendon	DST-002
Double Strand Peroneus Longus	DSP-002
Double Strand Anterior Tibialis	DAT-002
Double Strand Posterior Tibialis	DAP-002
Quadruple Strand Semitendinosus/Gracilis	QSG-002
Single Strand Gracilis	SSG-002
Single Strand Semitendinosus Tendon	SST-002



ACHILLES TENDON WITH BONE BLOCK



DOUBLE STRAND ANTERIOR TIBIALIS



SCAN OR CLICK

TO ORDER
877-255-6727
JRFORTHO.org/order

Nonsutured Aseptic Tendons

Nonsutured Aseptic Tendons continued...

ALLOGRAFT	PART CODE
Single Strand Anterior Tibialis	SAT-002
Quadriceps Tendon, Preshaped, 10 mm	QDT-102
Quadriceps Tendon w/ Bone	QDT-002

JRF Ortho offers a full complement of aseptic tendon allografts for knee reconstruction.

- ▶ Validated aseptic process
- ▶ Strict donor screening
- ▶ No pre or post irradiation steps
- ▶ No peroxide or peracetic acid
- ▶ Robust membrane filtration test

Safety & Tissue Integrity.

- ▶ Our processors use a proprietary bioburden reduction step that removes blood and lipids
- ▶ Utilizing highly sensitive NAT testing has resulted in no confirmed incidence of disease transmission
- ▶ Results clearly demonstrate that the liquid culture method is superior to swab cultures in microbial detection.*

*Dennis, J et al. A comparison of two microbial detection methods used in aseptic processing of musculoskeletal allografts tissues. Cell Tissue Bank. 2011;12:45-50.



SCAN OR CLICK

TO ORDER
877-255-6727
JRFORTHO.org/order



Meniscus

Meniscus

ALLOGRAFT	SIDE	PART CODE
Lateral Meniscus w/ Bone Block	Right	28325001
Lateral Meniscus w/ Bone Block	Left	28325002
Medial Meniscus w/ Bone Block	Right	28225001
Medial Meniscus w/ Bone Block	Left	28225002

JRF Ortho partners with Arthrex® to provide the ideally sized meniscus along with the needed instrumentation for your meniscal allograft transplant procedures.



LATERAL MENISCUS



MEDIAL MENISCUS



SCAN OR CLICK

TO ORDER
877-255-6727
JRFORTHO.org/order



JRFORTHO

The JRF Ortho Advantages:

- ▶ Gold standard for cartilage restoration
- ▶ Fastest OCA matching and predictable scheduling
- ▶ Most widely available viable cartilage solutions
- ▶ Increased efficiency in the OR with presutured tendon constructs
- ▶ Aseptic and low dose, low temperature sterilized tendons
- ▶ Preshaped fresh, viable cores provide optimal solutions for small, focal OCA defects

TO ORDER

877-255-6727
JRFORTHO.org/order

ONLINE ORDERING, SHIPPING, & RETURN POLICY

ONLINE ORDERING

Ordering with JRF Ortho is easier than ever! The JRF Ortho **online web portal*** allows you to order and manage grafts online! You can do the following:

- ▶ Place secure graft orders on any mobile device at any time of day.
- ▶ Track and view the status of your orders
- ▶ Select specific tendons from live inventory.
- ▶ Generate quotes as part of your tendon order
- ▶ Upload films

* JRFORTHO.org/order

TELEPHONE SUPPORT

Additionally, our ASC's are available to provide superior customer care 24/7 to handle all technical support needs and emergencies.

LOCATIONS Centennial, CO San Leandro, CA

PHONE 877-255-6727 **FAX** 303-649-1658

SHIPPING

JRF Ortho is committed to ensuring tissue allografts arrive on time, offering flexible shipping options to meet this goal. Shipping and/or handling fees are shown on each invoice.

RETURN POLICY

Frozen Tendons & Meniscus Returns

Members must complete **return request form*** online, prior to returning graft, in order to acquire a Return Authorization number.

- ▶ Must have the Return Authorization number written on the outside of the box
- ▶ Completed Return Authorization Form must be received within 30 days of issuance
- ▶ Each returned graft is subject to a \$250 restock fee
- ▶ The CUSTOMER is responsible for the return shipping
- ▶ If return instructions are not followed and graft is received in unacceptable condition no credit will be given

IMPORTANT: OSTEOCHONDRAL ALLOGRAFTS CANNOT BE RETURNED

* JRFORTHO.org/forms/returns

* FiberWire®, FiberLoop®, GraftLink®, SpeedGraft® and VersaGraft® are registered trademarks of Arthrex, Inc.

¹ Data on file, JRF Ortho



JRFORTHO

7245 S Havana St, Ste #300
Centennial, CO 80112

M 877-255-6727 **F** 303-649-1658

JRFORTHO.org